

SMF4L Series

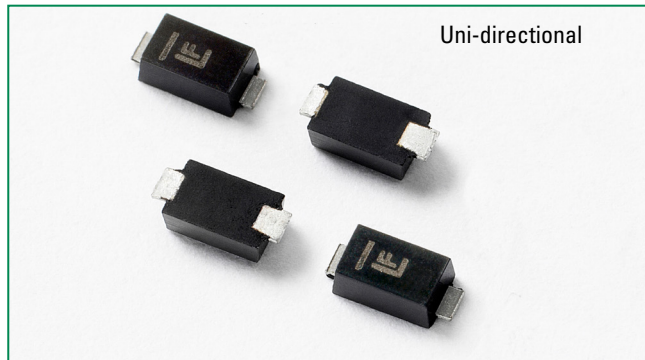

Agency Approvals

AGENCY	AGENCY FILE NUMBER
	E230531

Maximum Ratings and Thermal Characteristics ($T_A=25^\circ\text{C}$ unless otherwise noted)

Parameter	Symbol	Value	Unit
Peak Pulse Power Dissipation at $T_A=25^\circ\text{C}$ (Note 1)	8/20 μs (Note 2)	2000	W
	10/1000 μs (Note 3)	400	W
Thermal Resistance Junction to Ambient	$R_{\theta JA}$	220	$^\circ\text{C/W}$
Thermal Resistance Junction to Lead	$R_{\theta JL}$	100	$^\circ\text{C/W}$
Operating and Storage Temperature Range	T_J, T_{STG}	-55 to 150	$^\circ\text{C}$

Notes:

1. Non-repetitive current pulse, per Fig. 4 and derated above T_J (initial) = 25°C per Fig. 3.
2. SMF4L5.0A~SMF4L9.0A Peak Pulse Power Dissipation is 1850W min, 2000W typical @8/20 μs
3. SMF4L5.0A~SMF4L9.0A Peak Pulse Power Dissipation is 370W min, 400W typical @ 10/1000 μs

Functional Diagram

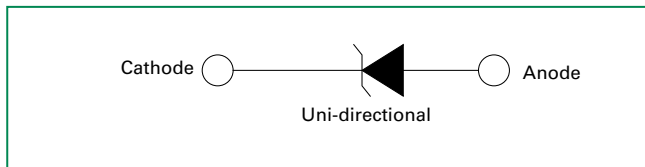

Description

The SMF4L series is packaged in the small SOD-123FL form factor and is designed specifically to protect sensitive electronic equipment from voltage transients induced by lightning and other transient voltage events.

Features

- 400W peak pulsepower capability at 10/1000 μs waveform, repetition rate (duty cycle): 0.01 %
- Compatible with industrial standard package SOD-123FL
- Low inductance, excellent clamping capability
- For surface mounted applications to minimize board space
- Typical failure mode is short from over-specified voltage or current
- Whisker test is conducted based on JEDEC JESD201A per its table 4a and 4c
- IEC-61000-4-2 ESD 30kV(Air), 30kV (Contact)
- ESD protection of data lines in accordance with IEC 61000-4-2
- EFT protection of data lines in accordance with IEC 61000-4-4
- Fast response time: typically less than 1.0ns from 0 Volts to V_{BR} min
- High temperature soldering: 260 $^\circ\text{C}/40$ seconds at terminals
- Glass passivated junction
- Built-in strain relief
- UL Recognized compound meeting flammability rating V-0
- Meet MSL level1, per J-STD-020, LF maximum peak of 260 $^\circ\text{C}$
- Matte tin lead-free plated
- Halogen-free and RoHS compliant
- Pb-free E3 means 2nd level interconnect is Pb-free and the terminal finish material is tin(Sn) (IPC/JEDEC J-STD-609A.01)

Applications

SMF4L devices are ideal for the protection of portable devices/hard drives, notebooks, V_{CC} busses, POS terminal, SSDs, power supplies, monitors, and vulnerable circuit used in other consumer applications.

Electrical Characteristics ($T_A=25^\circ\text{C}$ unless otherwise noted)

Part Number	Marking Code	Breakdown Voltage V_{BR} (Volts) @ I_T		Test Current I_T (mA)	Reverse Stand off Voltage V_R (V)	Maximum Reverse Leakage @ V_R I_R (μA)	Maximum Peak Pulse Current I_{pp} (A)	Maximum Clamping Voltage @ I_{pp} V_C (V)	Agency Approval 
		MIN	MAX						
SMF4L5.0A	KE	6.40	7.00	10	5.0	800	40.1	9.2	X
SMF4L6.0A	KG	6.67	7.37	10	6.0	800	35.9	10.3	X
SMF4L6.5A	KK	7.22	7.98	10	6.5	500	33.1	11.2	X
SMF4L7.0A	KM	7.78	8.60	10	7.0	200	30.9	12.0	X
SMF4L7.5A	KP	8.33	9.21	1	7.5	100	28.7	12.9	X
SMF4L8.0A	KR	8.89	9.83	1	8.0	50	27.2	13.6	X
SMF4L8.5A	KT	9.44	10.40	1	8.5	20	25.7	14.4	X
SMF4L9.0A	KV	10.00	11.10	1	9.0	10	24.1	15.4	X
SMF4L10A	KX	11.10	12.30	1	10	5	23.5	17.0	X
SMF4L11A	KZ	12.20	13.50	1	11	1	22.0	18.2	X
SMF4L12A	LE	13.30	14.70	1	12	1	20.1	19.9	X
SMF4L13A	LG	14.40	15.90	1	13	1	18.6	21.5	X
SMF4L14A	LK	15.60	17.20	1	14	1	17.2	23.2	X
SMF4L15A	LM	16.70	18.50	1	15	1	16.4	24.4	X
SMF4L16A	LP	17.80	19.70	1	16	1	15.4	26.0	X
SMF4L17A	LR	18.90	20.90	1	17	1	14.5	27.6	X
SMF4L18A	LT	20.00	22.10	1	18	1	13.7	29.2	X
SMF4L20A	LV	22.20	24.50	1	20	1	12.3	32.4	X
SMF4L22A	LX	24.40	26.90	1	22	1	11.3	35.5	X
SMF4L24A	LZ	26.70	29.50	1	24	1	10.3	38.9	X
SMF4L26A	ME	28.90	31.90	1	26	1	9.5	42.1	X
SMF4L28A	MG	31.10	34.40	1	28	1	8.8	45.4	X
SMF4L30A	MK	33.30	36.80	1	30	1	8.3	48.4	X
SMF4L33A	MM	36.70	40.60	1	33	1	7.5	53.3	X
SMF4L36A	MP	40.00	44.20	1	36	1	6.9	58.1	X
SMF4L40A	MR	44.40	49.10	1	40	1	6.2	64.5	X
SMF4L43A	MT	47.80	52.80	1	43	1	5.8	69.4	X
SMF4L45A	MV	50.00	55.30	1	45	1	5.5	72.7	X
SMF4L48A	MX	53.30	58.90	1	48	1	5.2	77.4	X
SMF4L51A	MZ	56.70	62.70	1	51	1	4.9	82.4	X
SMF4L54A	NE	60.00	66.30	1	54	1	4.6	87.1	X
SMF4L58A	NG	64.40	71.20	1	58	1	4.3	93.6	X
SMF4L60A	NK	66.70	73.70	1	60	1	4.1	96.8	X
SMF4L64A	NM	71.10	78.60	1	64	1	3.9	103.0	X
SMF4L70A	NP	77.80	86.00	1	70	1	3.5	113.0	X
SMF4L75A	NR	83.30	92.10	1	75	1	3.3	121.0	X
SMF4L78A	NT	86.70	95.80	1	78	1	3.2	126.0	X
SMF4L85A	NV	94.40	104.00	1	85	1	2.9	137.0	X
SMF4L90A	NX	100.00	111.00	1	90	1	1.4	146.0	X
SMF4L100A	NZ	111.00	123.00	1	100	1	1.2	162.0	X
SMF4L110A	OE	122.00	135.00	1	110	1	1.1	177.0	X
SMF4L120A	OG	133.00	147.00	1	120	1	1.0	193.0	X
SMF4L130A	OK	144.00	159.00	1	130	1	1.0	209.0	X
SMF4L150A	OM	167.00	185.00	1	150	1	0.8	243.0	X
SMF4L160A	OP	178.00	197.00	1	160	1	0.8	259.0	X
SMF4L170A	OR	189.00	209.00	1	170	1	0.7	275.0	X
SMF4L180A	OT	201.00	222.00	1	180	1	0.7	292.0	X
SMF4L188A	OV	209.00	231.00	1	188	1	0.7	304.0	X
SMF4L200A	OX	224.00	247.00	1	200	1	0.6	324.0	X
SMF4L220A	OZ	246.00	272.00	1	220	1	0.6	356.0	X
SMF4L250A	PE	279.00	309.00	1	250	1	0.5	405.0	X

Notes:

- V_{BR} measured after I_T applied for 300 μs , I_T = square wave pulse or equivalent.
- Surge current waveform per 10/1000 μs exponential wave and derated per Fig.2.
- All terms and symbols are consistent with ANSI/IEEE C62.35.

I-V Curve Characteristics

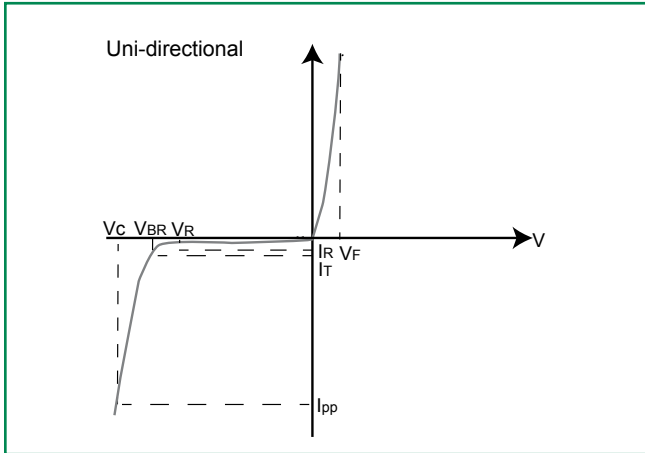

- P_{PPM} Peak Pulse Power Dissipation** – Max power dissipation
- V_R Stand-off Voltage** – Maximum voltage that can be applied to the TVS without operation
- V_{BR} Breakdown Voltage** – Maximum voltage that flows through the TVS at a specified test current (I_T)
- V_C Clamping Voltage** – Peak voltage measured across the TVS at a specified I_{ppm} (peak impulse current)
- I_R Reverse Leakage Current** – Current measured at V_R
- V_F Forward Voltage Drop for Uni-directional**

Ratings and Characteristic Curves ($T_A=25^\circ\text{C}$ unless otherwise noted)

Figure 1 - TVS Transients Clamping Waveform

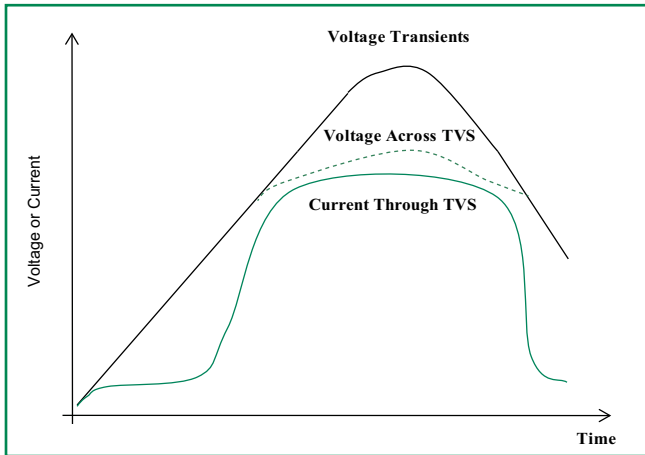
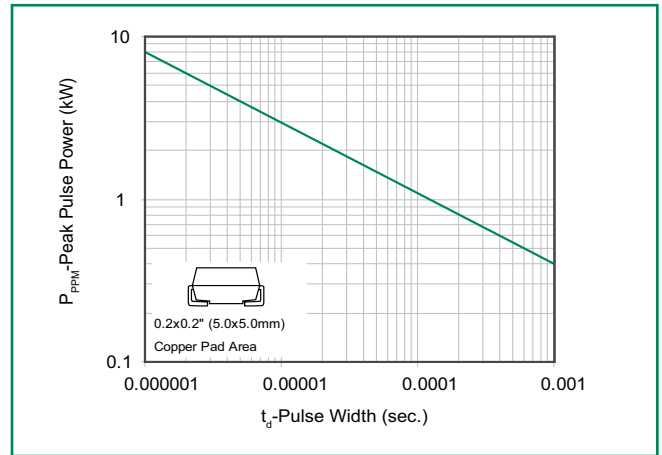

Figure 2 - Peak Pulse Power Rating Curve



continues on next page.

Ratings and Characteristic Curves ($T_A=25^\circ\text{C}$ unless otherwise noted) (Continued)

Figure 3 - Peak Pulse Power Derating Curve

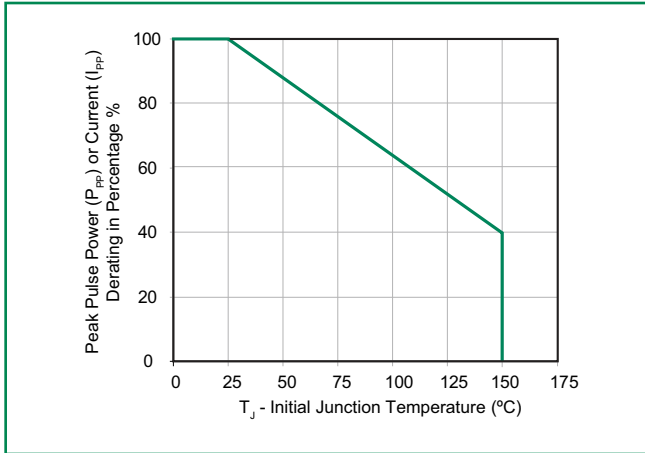

Figure 4 - Pulse Waveform - 10/1000 μ S

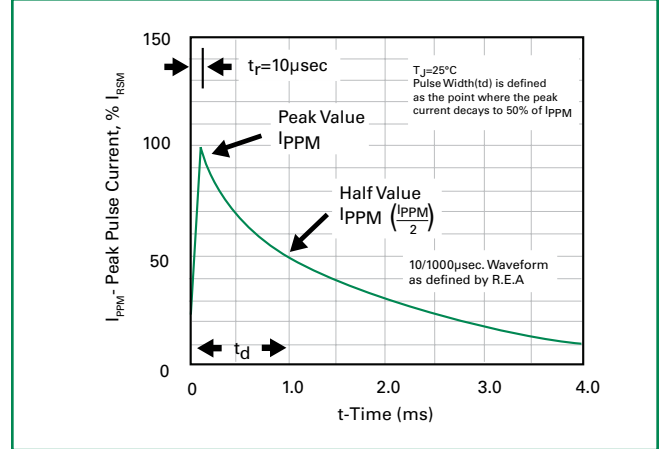

Figure 5 - Forward Voltage

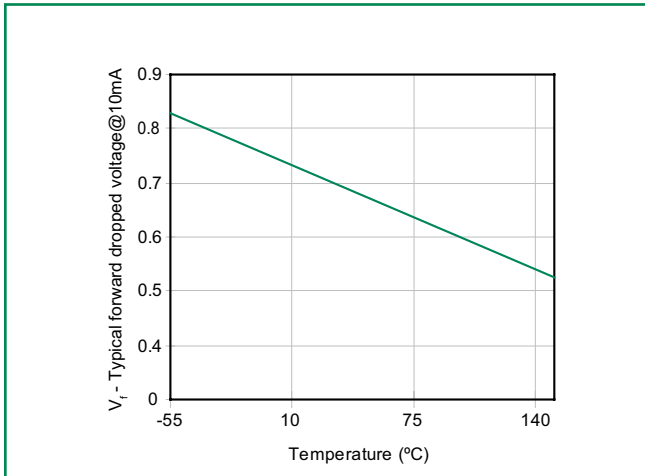

Figure 6 - Typical Junction Capacitance

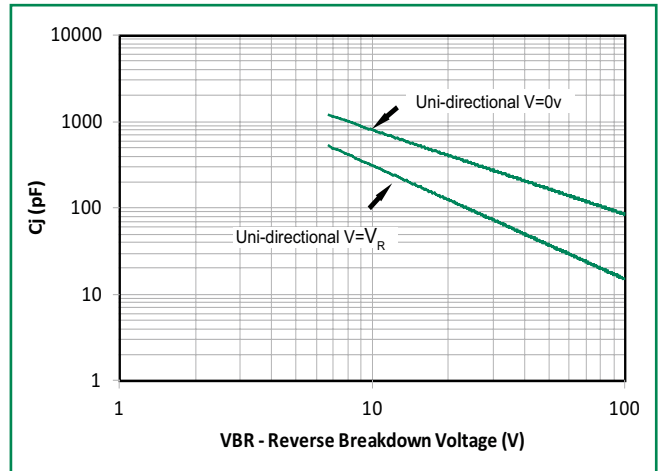

Figure 7 - Peak Forward Voltage Drop vs. Peak Forward Current

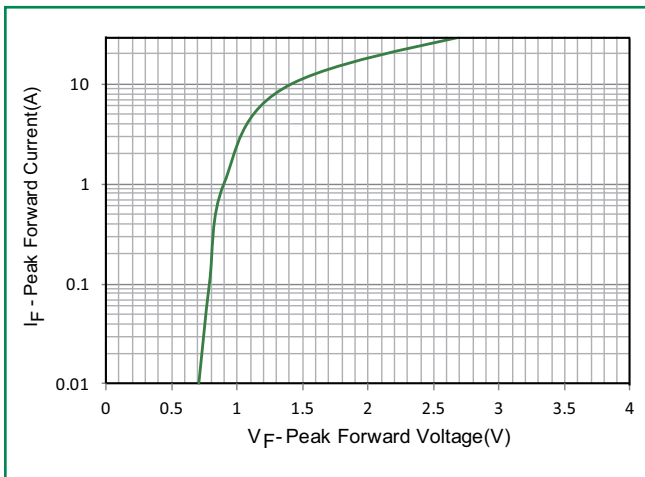
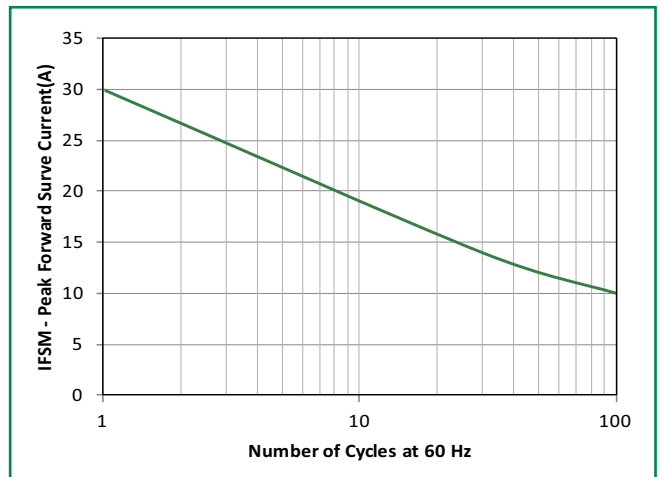
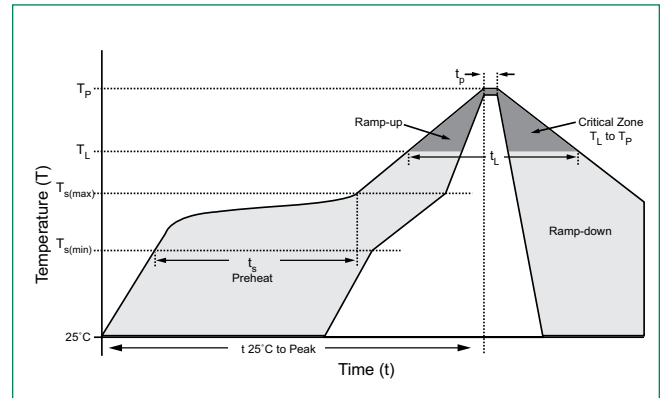

Figure 8 - Maximum Non-Repetitive Forward Surge Current Uni-Directional Only



Soldering Parameters

Reflow Condition		Lead-free assembly
Pre Heat	- Temperature Min ($T_{s(min)}$)	150°C
	- Temperature Max ($T_{s(max)}$)	200°C
	- Time (min to max) (t_s)	60 – 180 secs
Average ramp up rate (Liquidus Temp (T_A) to peak)		3°C/second max
$T_{s(max)}$ to T_A - Ramp-up Rate		3°C/second max
Reflow	- Temperature (T_A) (Liquidus)	217°C
	- Time (min to max) (t_s)	60 – 150 seconds
Peak Temperature (T_p)		260 ^{+0/-5} °C
Time within 5°C of actual peak Temperature (t_p)		20 – 40 seconds
Ramp-down Rate		6°C/second max
Time 25°C to peak Temperature (T_p)		8 minutes Max.
Do not exceed		260°C



Physical Specifications

Case	SOD-123FL plastic over glass passivated junction
Polarity	Color band denotes cathode except bipolar
Terminal	Matte tin-plated leads, solderable per JESD22-B102
Body Material (Molded Compound)	Flammability (UL Recognized compound meeting flammability rating V-0)

Environmental Specifications

High Temp. Storage	JESD22-A103
HTRB	JESD22-A108
Temperature Cycling	JESD22-A104
MSL	JEDEC-J-STD-020, Level 1
H3TRB	JESD22-A101
RSH	JESD22-A111

Dimensions - SOD-123FL Package

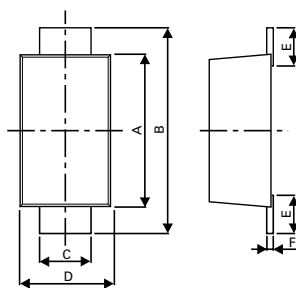

Mounting Pad Layout

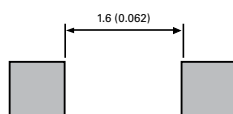

Dimensions	Millimeters		Inches	
	Min	Max	Min	Max
A	2.90	3.10	0.114	0.122
B	3.50	3.90	0.138	0.154
C	0.85	1.05	0.033	0.041
D	1.70	2.00	0.067	0.079
E	0.43	0.83	0.017	0.033
F	0.10	0.25	0.004	0.010
G	0.00	0.10	0.000	0.004
H	0.90	1.08	0.035	0.043

Part Numbering System

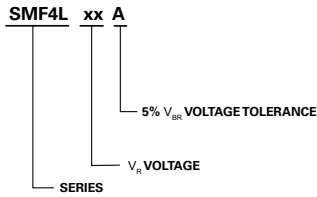

Part Marking System

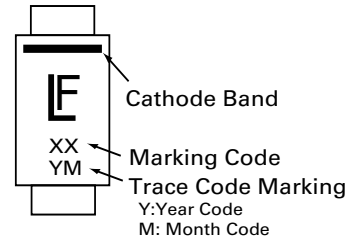

Packaging Options

Part number	Component Package	Quantity	Packaging Option	Packaging Specification
SMF4LXXX	SOD-123FL	3000	Tape & Reel – 8mm tape/7" reel	EIA RS-481

Tape and Reel Specification

